

SINGLE

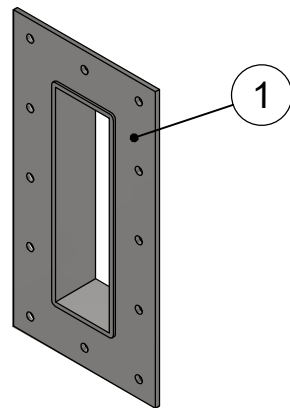

+SINGLE

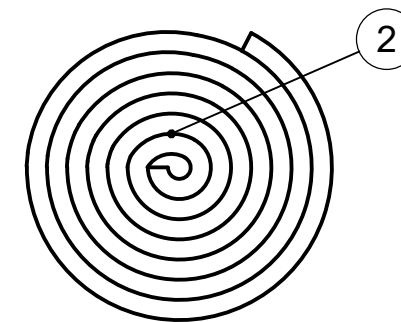
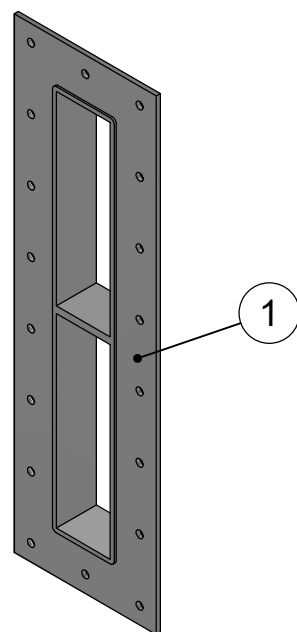

COMBINATION

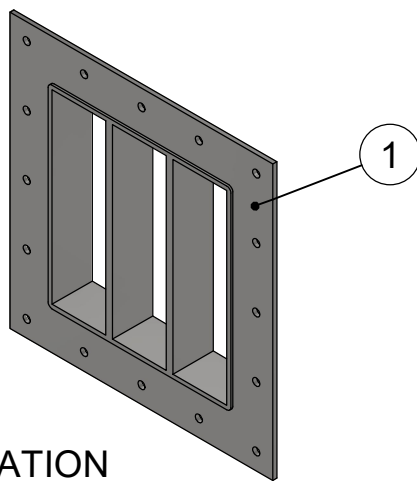

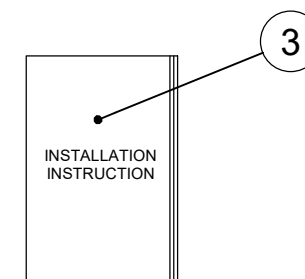
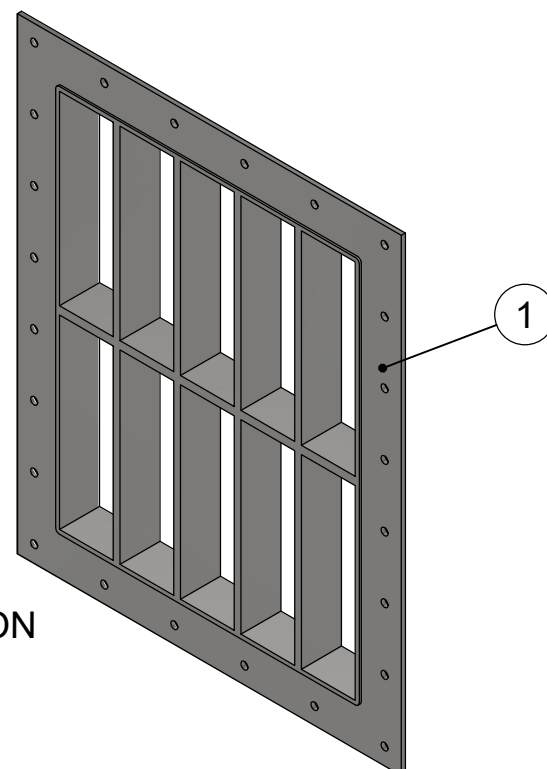

+COMBINATION



|   |   |                          |          |
|---|---|--------------------------|----------|
| 3 | 1 | INSTALLATION INSTRUCTION |          |
| 2 | - | TSL 15X6 EPDM            | S1605275 |
| 1 | 1 | +COMBINATION FRAME       | S1582430 |
| 1 | 1 | COMBINATION FRAME        | S1597868 |
| 1 | 1 | +SINGLE FRAME            | S1597869 |
| 1 | 1 | SINGLE FRAME             | S1597868 |

| ITEM   | QTY | Designation                              | Specification                  |              |       |                   | Weight    |
|--|-----|--|--------------------------------|--------------|-------|-------------------|-----------|
| General tolerances used for manufacturing shown in document DOC-002180 |     | Designed by/date<br>se-henols 2024-04-23 | Latest save date<br>2024-08-26 | Format<br>A3 | Scale | Sheet no<br>1 / 1 | TotWeight |

|   |   |  |   |
|---|---|--|---|
| <br>www.roxtec.com | Title<br>GHM80 FRAME INCL. TSL. 15x6<br>SINGLE, +SINGLE, COMB. AND +COMB. FRAME |  | Projection<br>method<br> |
|   | Restricted due to<br>Information drawing  |  |   |
|   |   |  | Rev<br>C  |

|     |                  |            |           |
|-----|------------------|------------|-----------|
| C   | LAYOUT CHANGED   | 2024-08-20 | se-marfre |
| Rev | Type of revision | Date       | Sign      |