

SINGLE

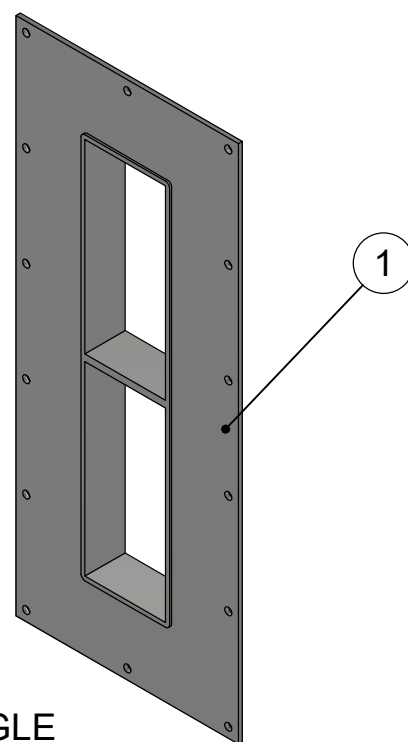

+SINGLE

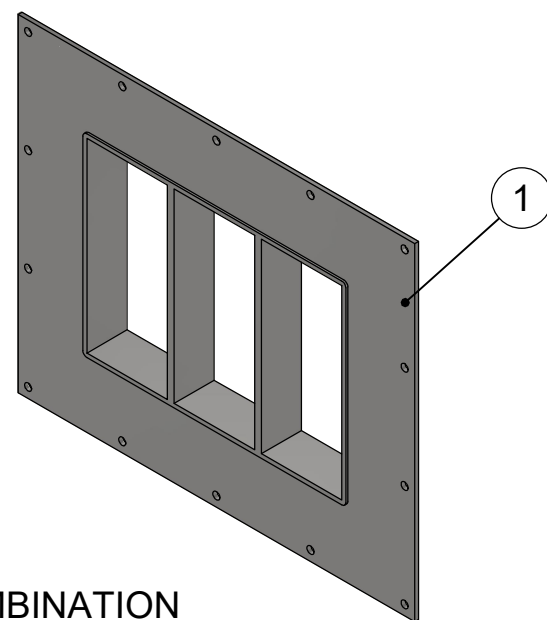
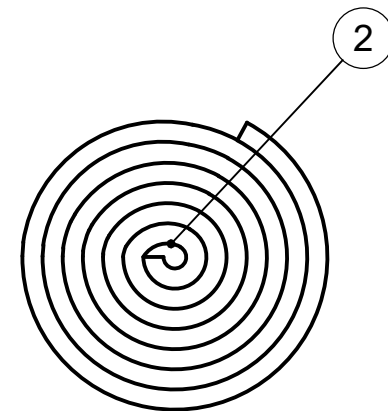

COMBINATION

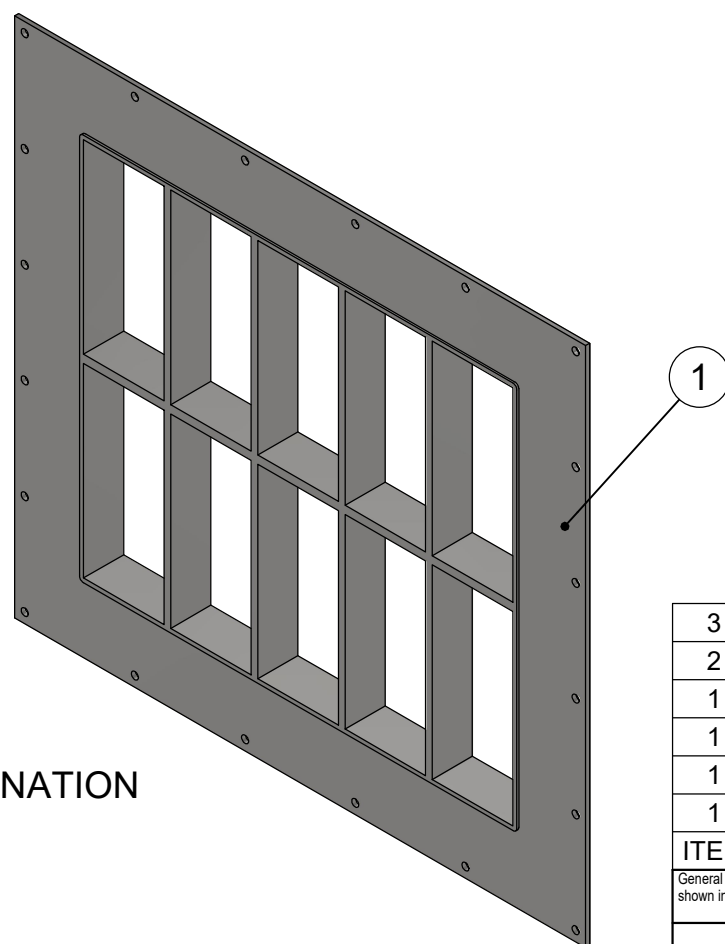

+COMBINATION

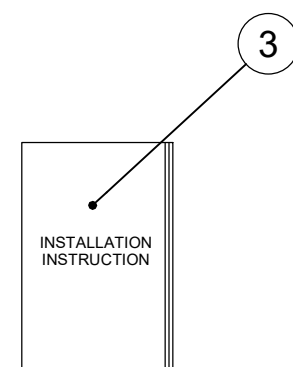

3	1	INSTALLATION INSTRUCTION	
2	1	TSL 8X8 BUTYL	S1501708
1	1	+COMBINATION FRAME	S1025602
1	1	COMBINATION FRAME	S1025601
1	1	+SINGLE FRAME	S1025600
1	1	SINGLE FRAME	S1025601

ITEM	QTY	Designation	Specification				Weight
General tolerances used for manufacturing shown in document DOC-002180		Designed by/date	Latest save date	Format	Scale	Sheet no	TotWeight
		se-henols 2023-11-08	2024-08-28	A3		1 / 1	

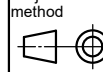
 www.roxtec.com	Title GH FL100 FRAME KIT		Projection method 
	Restricted due to Information drawing		
			Rev C

C		2024-08-21	se-marfre
Rev	Type of revision	Date	Sign