

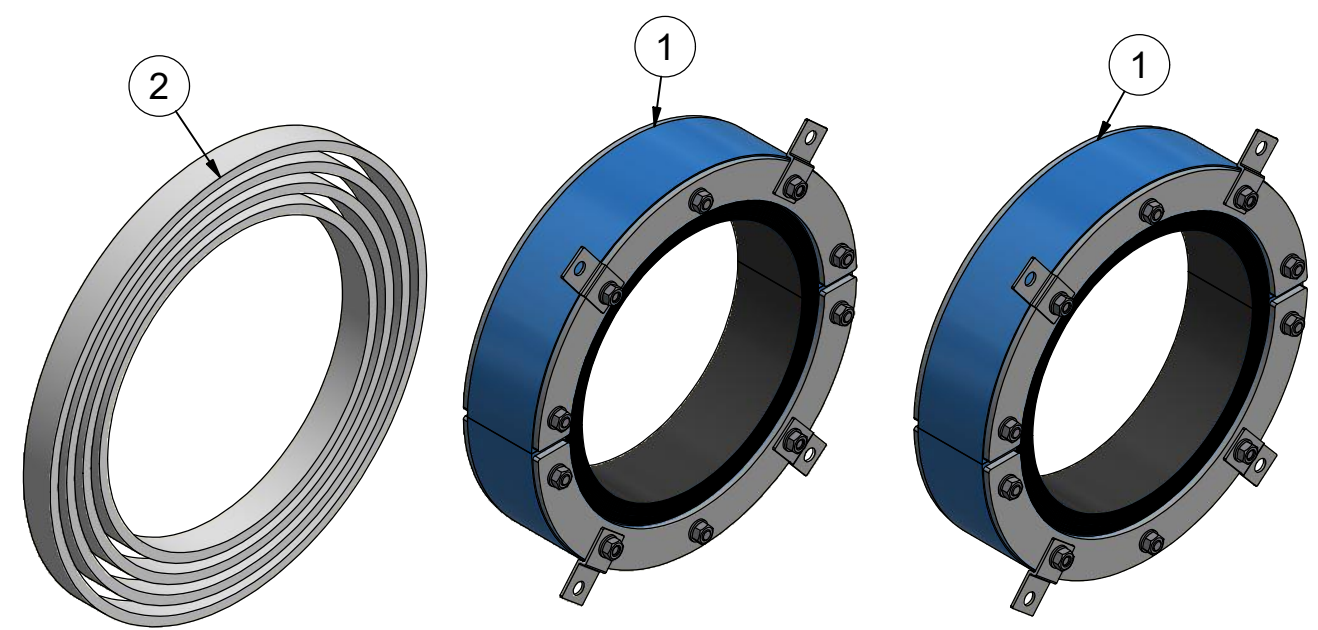

RS PPS SEAL

SEAL	Ø RANGE (mm)	Dy (mm)	SW
RS PPS 225 WOC	151-181	225	10
RS PPS 250 WOC	176-206	250	10
RS PPS 300 WOC	206-236	300	13
RS PPS 350 WOC	244-286	350	13
RS PPS 400 WOC	294-336	400	13
RS PPS 450 WOC	344-386	450	17

C

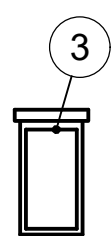
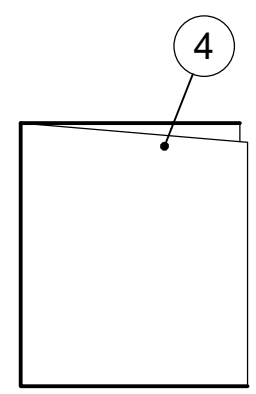
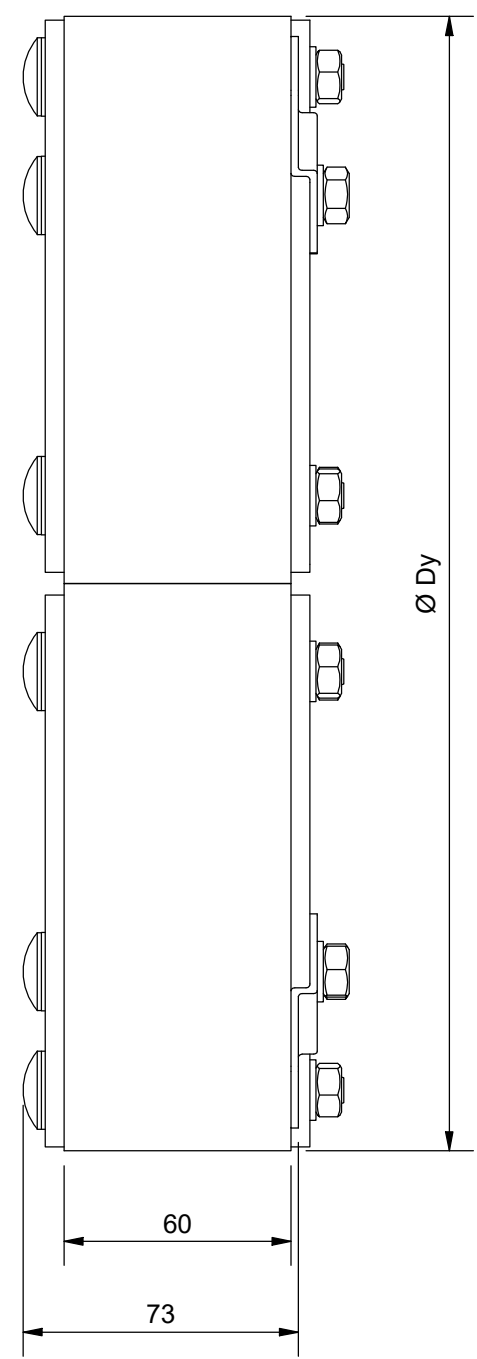
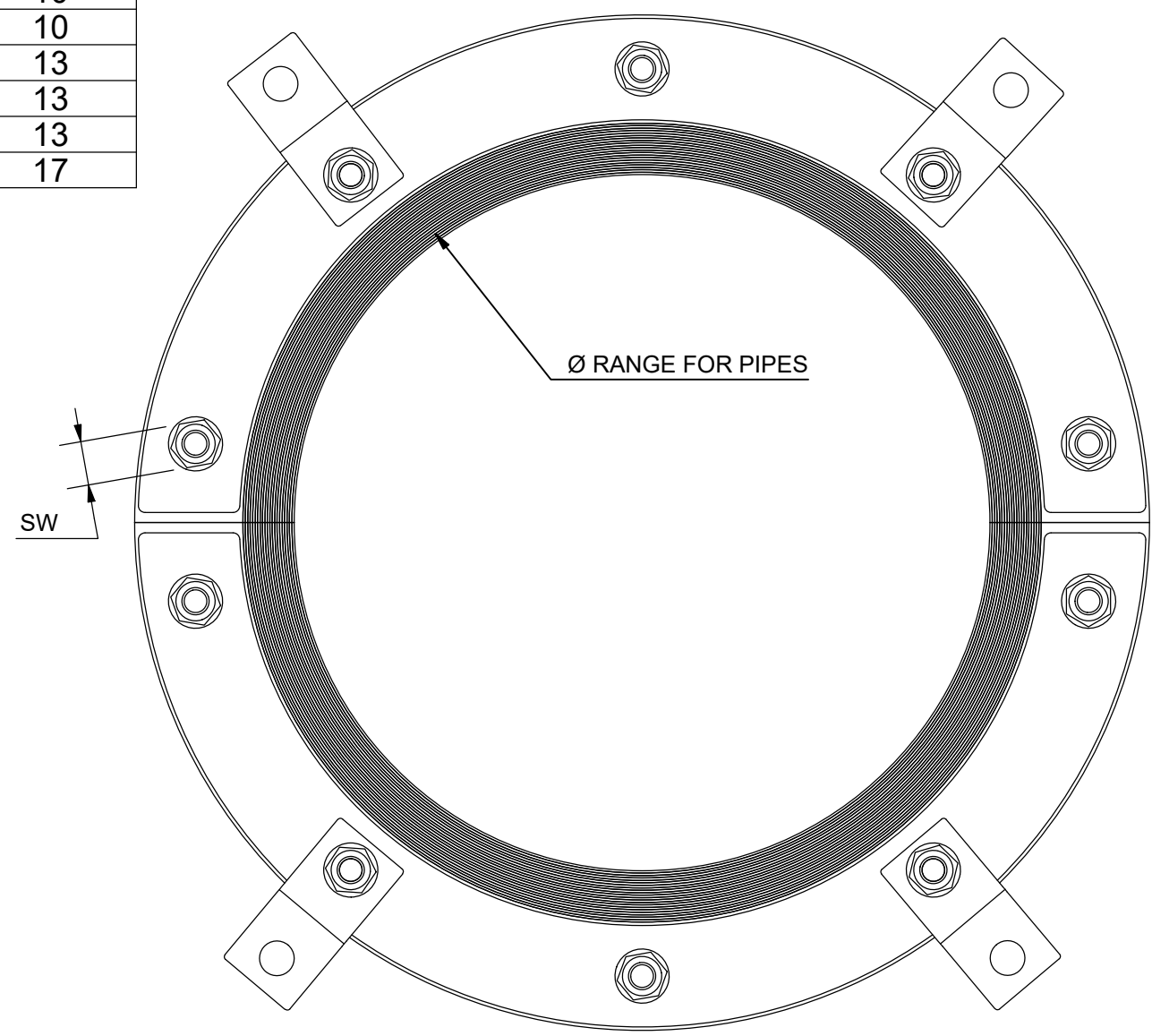

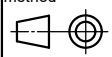
4	1	INSTALLATION INSTRUCTION						
3	1	LUBRICANT	TALLOW					
2	1	INTUMESCENT MATERIAL	SELF ADHESIVE ROLL					
1	2	RS SEAL	S1006598					
ITEM	QTY	Designation		Specification				Weight
General tolerances used for manufacturing shown in document DOC-002180		Designed by/date	Latest save date	Format	Scale	Sheet no	TotWeight	
		se-jenboh	2007-12-14	A3		1 / 1	N/A	
 www.roxtec.com		Title				Projection method		
		RS PPS SEALS RS PPS 225-450						
Rev		Type of revision		Drawing number		Rev		
C		SIZE 450 ADDED		S1012814		C		

C	SIZE 450 ADDED	2021-08-31	se-jenboh
Rev	Type of revision	Date	Sign